

Ripple - Ring Ø700

BIG - Bjarke Ingels Group

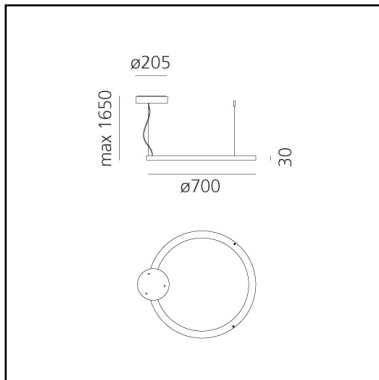

IP20   Dimmerable: 



LUMINAIRE

- Watt: **50W**
- Delivered lumens output: **3350lm**
- CCT: **3000K**
- Efficiency: **51%**
- Efficacy: **67.00lm/W**
- CRI: **90**

Notes

To obtain the same luminous flux in case of compositions with several Ripple of different sizes side by side, set the drivers as follows:
Ripple 500 - 20W 1493lm
Ripple 700 - 29W 2205lm
Ripple 900 - 38W 2913lm

DESCRIPTION

This suspension system shapes the qualities of space through molecular growth, combining light and sound absorption. Comprised of circular structures in three different diameters, it works through layers of performance that can be modulated as required.

The structures can be simple electrical connection elements, unveil "pure" light or be enriched by a diffuser which, in addition to interacting with the light, offers sound absorption properties.

The basic element of the product is a circular ring whose profile is a synthesis of optics and mechanical engineering. Ripple elements can also be combined in increasingly complex customised solutions: from simple lines or geometries of elements with a constant diameter, to compositions that combine different diameters in a more organic and free growth, through to show-stopping, striking solutions.

In addition, the possibility of using the rings as only a connection structure allows spatial distribution of the active elements without creating any waste or excess, focusing light only where it is needed.

Once again, Artemide's project with BIG is guided by a strong idea of interaction with spaces, an open, modular and scalable solution that combines technological innovation with compositional intelligence, translating all this into something apparently simple but striking and full of potential.

This freedom of configuration is then mirrored by the flexibility in management granted by interaction with Artemide App.

PRODUCT CODE: 2061010A

FEATURES

- Article Code: **2061010A**
- Colour: **White**
- Installation: **Suspension**
- Material: **Heat-conducting moulded plastic**
- Series: **Design Collection, 2020 Artemide Collection**
- Environment: **Indoor**
- design by: **BIG - Bjarke Ingels Group**

DIMENSIONS

- Height: **cm 3**
- Diameter: **cm 70**
- Base Diameter: **cm 20.5**
- Max Height from ceiling: **cm 165**